

# SUNBLADE BOX SHROUD

**SB-BOX-2TB**  
TOP AND BOTTOM  
CONFIGURATION

## ORDER FORM

The SB-BOX-2TB configuration of the SUNBLADE BOX Shroud comprises of a 2 piece build. A distinctive, bold aesthetic profile for modern architecture. Crafted from a highly durable extruded profile, providing superior durability and weather resistance. Designed as a robust modular kit, this facilitates secure delivery and assembly; reducing the challenges associated with site specific accuracy. SUNBLADE shrouds adhere to Australian standards and provide consideration for building sustainability through solar shading.

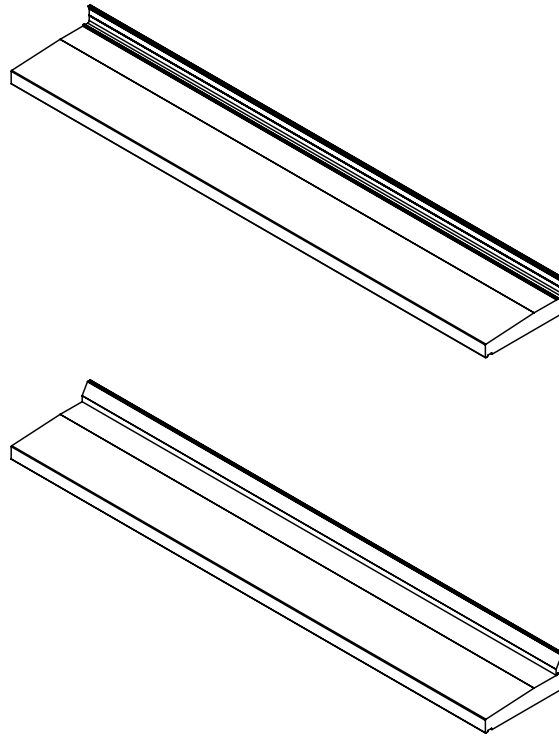

|                           |                                      |                        |                         |
|---------------------------|--------------------------------------|------------------------|-------------------------|
| <b>Category</b>           | Shroud                               | <b>Supplied As</b>     | Flat Pack + End Plates  |
| <b>Profile Name</b>       | SUNBLADE BOX SHROUD                  | <b>Inclusions</b>      | Covers                  |
| <b>Profile</b>            | Fixed 100mm (50mm-40mm Taper Nose)   | <b>Profile Depth</b>   | Fixed 270mm             |
| <b>Material</b>           | Aluminium 6060 T5                    | <b>Material Weight</b> | 6.523 kg/m <sup>2</sup> |
| <b>Max Height</b>         | N/A                                  | <b>Density</b>         | 2.70g/m <sup>3</sup>    |
| <b>Max Width</b>          | 6500mm*                              | <b>Wind Rating</b>     | 25m Above Ground        |
| <b>Fixing Flange</b>      | Fixed 50mm Flange                    | <b>Certification</b>   | AS1530.3                |
| <b>Fixing Suitability</b> | Steel, LGS, Timber, Concrete & Brick | <b>Sides</b>           | 2                       |

It is the responsibility of the customer to ensure compliance with specific project requirements, wind ratings and that the structural integrity of the building and substrate structure is suitable for connection of the window shroud. The site engineer is responsible for reviewing and confirming all installation instructions, fixings and drawings. Engineering certificate is not included as standard.

\*Maximum Height and Widths may be limited by and/or determined by combinations that exceed engineering, material length and/or powder coat limitations.

Brand names, designs and content in this document are strictly copyright © 2024 McKinna Group ABN 51 088 110 169 McKinna Group are not liable for any errors, omissions, or inaccuracies in the information or for any decisions or actions taken in reliance on the information. We reserve the right to update, change, or correct any information at any time without notice.

VISIT US ONLINE  
[MCKINNAGROUP.COM.AU](https://www.mckinnagroup.com.au)

HEAD OFFICE  
116 MALCOLM ROAD, BRAESIDE  
VICTORIA 3195 AUSTRALIA

CONNECT  
[sales@mckinnagroup.com.au](mailto:sales@mckinnagroup.com.au)  
03 9580 4440

**MCKINNA**

# SUNBLADE BOX SHROUD

**SB-BOX-2TB**  
TOP & BOTTOM  
CONFIGURATION

## ORDER FORM

Quantity

### Inside Width

**A**  mm

Min 100mm Max 6500mm

### Depth

**B**  270mm Fixed

### Flange

**C**  50mm Fixed

### Coating Brand

### Coating Range

### Coating Colour

Guide available online visit [mckinnagroup.com.au/coating-colours](http://mckinnagroup.com.au/coating-colours)

### Standard Product Warranty

7 Years  
Workmanship & Materials

Subject to conditions, further information can  
be found at [mckinnagroup.com.au/warranty](http://mckinnagroup.com.au/warranty)

### Extended Coating Warranty

No  Yes

Obtaining a specialty warranty from the coating brand is  
subject to location, usage, processing fees and approvals.

## SECTION VIEW

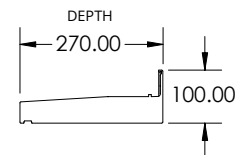
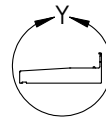
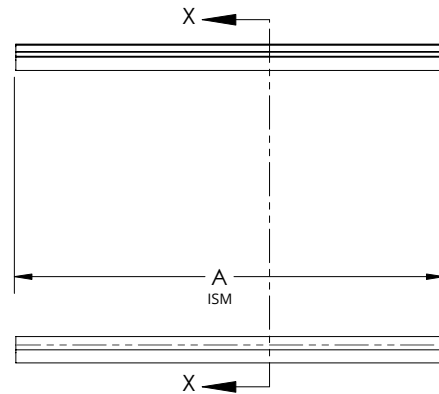
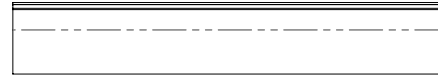

DETAIL Y  
FIXED PROFILE  
FLANGE 50mm  
TAPER NOSE  
50mm-40mm

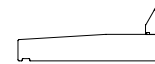
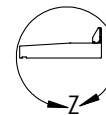

CROSS SECTION X-X

DETAIL Z

## CUSTOMER INFORMATION

All orders are subject to our Terms and Conditions of Trade, for more details please visit [mckinnagroup.com.au/orderterms](http://mckinnagroup.com.au/orderterms)

### Company Name

### Full Name - Order Request

### Telephone

### Email Address

### Project Name

### Project Location

### Delivery Address

VISIT US ONLINE  
[MCKINNAGROUP.COM.AU](http://MCKINNAGROUP.COM.AU)

HEAD OFFICE  
116 MALCOLM ROAD, BRAESIDE  
VICTORIA 3195 AUSTRALIA

CONNECT  
[sales@mckinnagroup.com.au](mailto:sales@mckinnagroup.com.au)  
03 9580 4440

**MCKINNA**